

Rev. No.	DESCRIPTION	DATE	DS.	CH.	AP.
△					
△					
△					

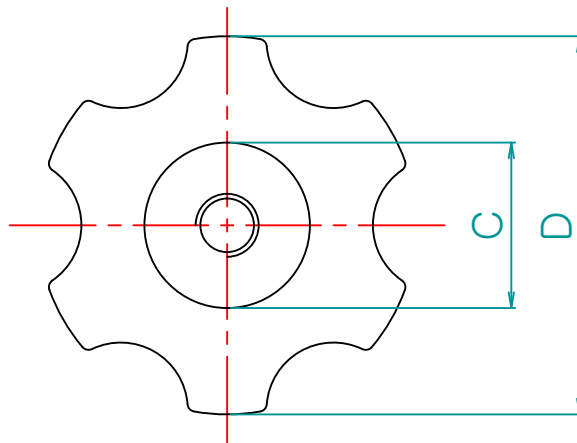
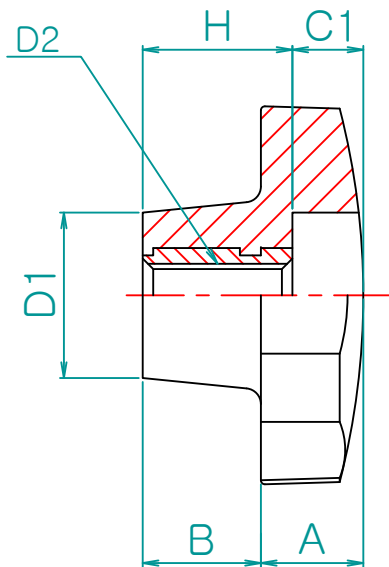
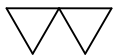

unit : mm

제품명	D2	A	B	C	C1	D1	H	D
SON-L	M16	19	26	42	30	36	30	79
	M14							
	M12							
	M10							
	M8							
SON-M	M12	16	24	29	13	29	27	62
	M10							
	M8							
SON-S	M10	13	15	20	9	23	19	48
	M8							
	M6							

Note

1. 특징 :

2. 용도 :

	재질	표면처리
노브부	페놀수지	흑색유광
나사부	황동(인서트)	-

Dimension (mm)	Precision	Material	Dwg. No.	Q'TY
0.5~3		페놀수지		**
3~6	±0.05	Finish	Part Name.	Weight
6~30	±0.1	흑색유광	**	-
30~120	±0.15	Revision	Ass'y Name	Scale
120~315	±0.2	-	**	1:1
315~1000	±0.3	Date	Model No.	
1000~2000	±0.5	2010-09-07	SON	
		Designed by Shin S H		
		Checked by	Approved by	
KS B 0412에 준함				