

Rev. No.	DESCRIPTION	DATE	DS.	CH.	AP.
△					
△					
△					

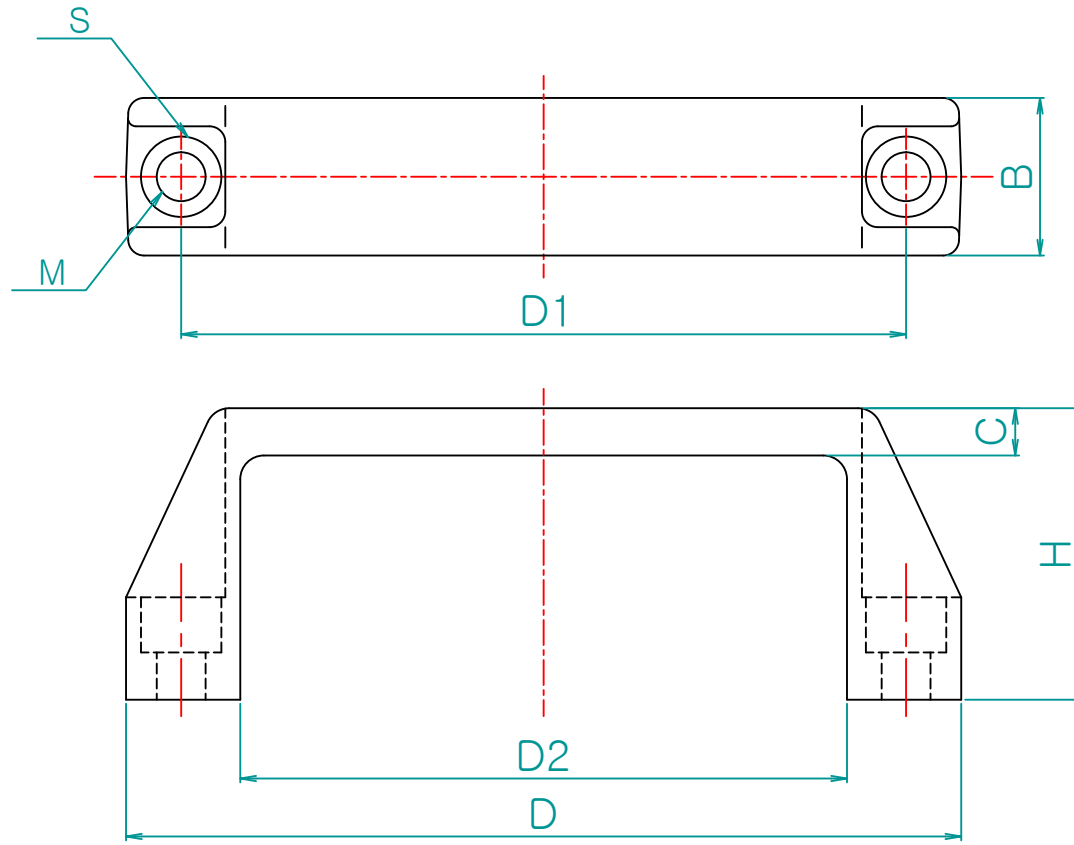
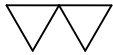

unit : mm

제품명	D	D1	D2	H	B	C	S	M
AGS110	104	90	72	37	20	6	10	6
AGS134	134	112	91	44	24	7	13	8
AGS150	150	126	105	48	25	8	13	8
AGS175	175	152	131	50	26	8	23	8

Note

1. 특징 :

2. 용도 :

	재 질	표면처리
그립부	나일론(Polyamide)	흑 색

Dimension (mm)	Precision	Material	Dwg. No.	Q'TY
0.5~3		나일론(Polyamide)		**
3~6	±0.05	Finish	Part Name.	Weight
6~30	±0.1	흑색유광	**	-
30~120	±0.15	Revision	Ass'y Name	Scale
120~315	±0.2	-	**	1:1
315~1000	±0.3	Date	Model No.	
1000~2000	±0.5	2010-09-07	AGS	
		Designed by Shin S H		
		Checked by	Approved by	
KS B 0412에 준함				