

Free - Hinge

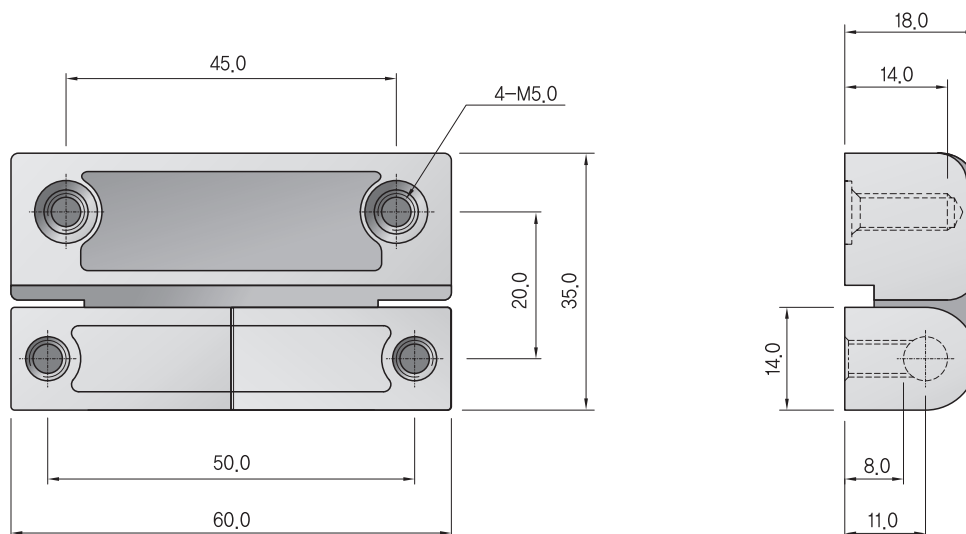

- 세련된 디자인
- 재 질: 아연 합금, 스테인레스
- 표면처리: 무광, 흑색크롬도금
- Stylish body design
- Material : Zinc Alloy, Stainless Steel
- Finish : Chrome plated Non-Glossy or Black

WS-100VN Free-Hinge



Part Numbers

Non-Torque

WS - H100VN - **F**

F = Surface Finish Code

03 = Non-Glossy Chrome

04 = Black Chrome

05 = Black Paint